

Figures

CAPITA SYMONDS

successful people, projects and performance

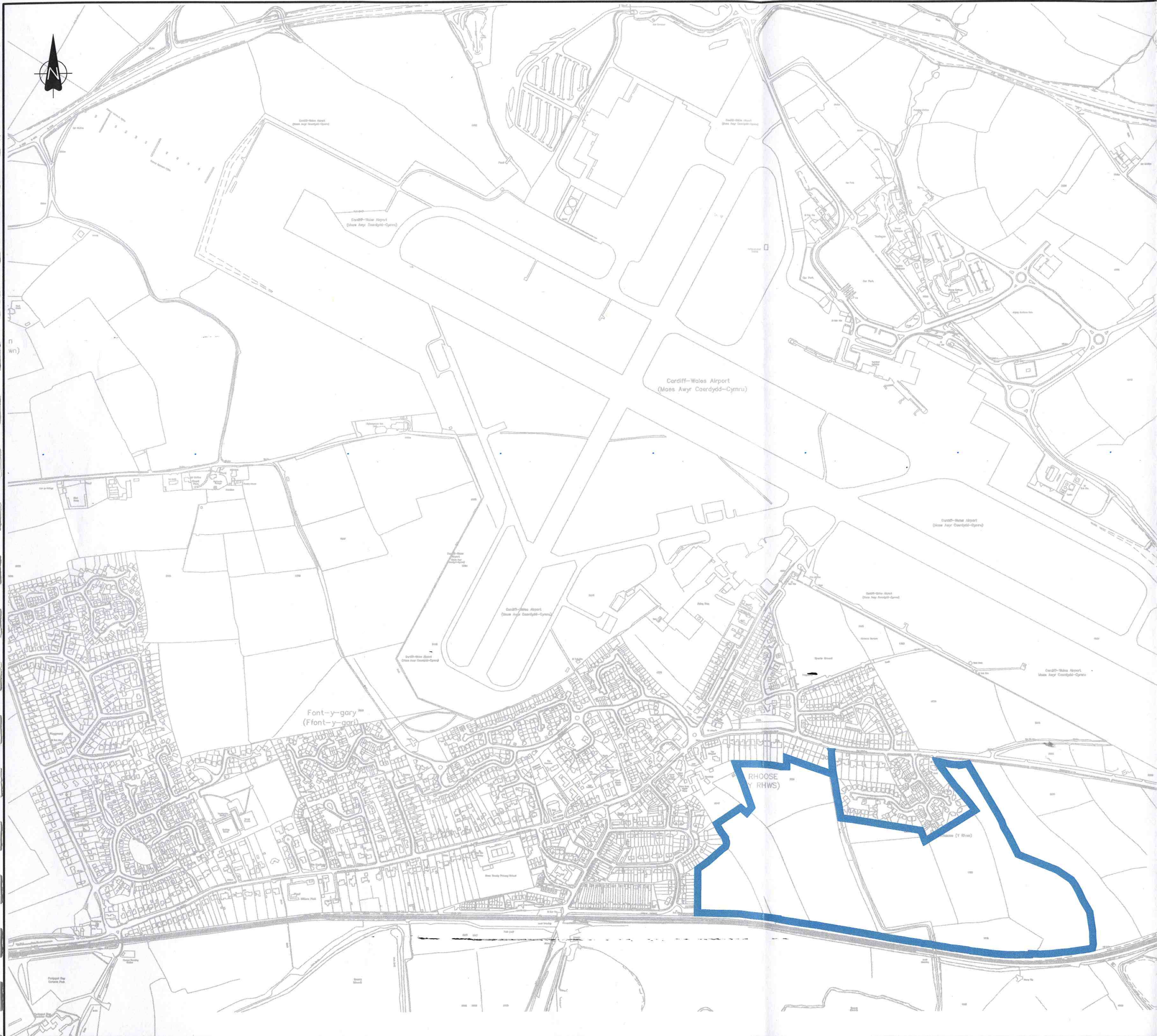

DRG. No. Figure 1.1 REVISION REF.

KEY

 PROPOSED DEVELOPMENT SITE

RECEIVED

22 APR 2008

ENVIRONMENTAL AND ECONOMIC REGENERATION

© Crown copyright. All rights reserved. Licence No. 100020449

ISSUE	AMENDMENTS	DRAWN	CHK'D	DATE
-	-	-	-	-



LAND NORTH OF THE RAILWAY LINE, RHOOSE, VALE OF GLAMORGAN

LOCATION PLAN

CAPITA SYMONDS

Capita Gwent Consultancy Ltd.
Ty Gwent, Lake View, Llantarnam Park, Cwmbran, South Wales. NP44 3HR
Tel: 01633 463333 Fax: 01633 463399

DRAWN	O. JONES	03/05	SCALE:
CHECKED	O. J. B. SMITH	03/05	NOT TO SCALE

DRG. No. Figure 1.1 REVISION REF.

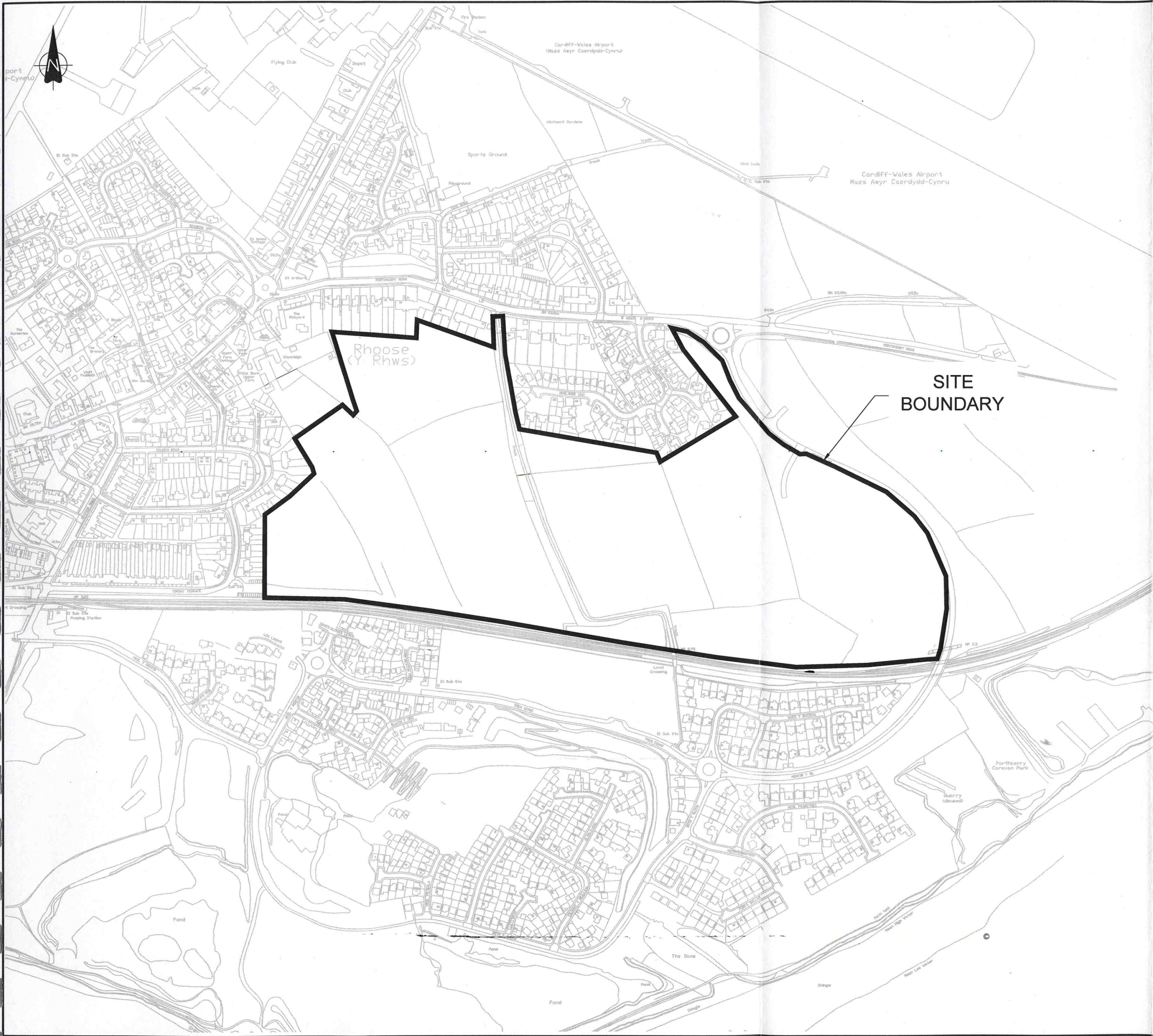

RECEIVED

22 APR 2008

ENVIRONMENTAL AND ECONOMIC REGENERATION

© Crown copyright. All rights reserved.
Licence No. 100020449

ISSUE	AMENDMENTS	DRAWN	CHK'D	DATE
-	-	-	-	-



LAND NORTH OF THE RAILWAY LINE,
RHOOSE, VALE OF GLAMORGAN

PROPOSED SITE AREA

CAPITA SYMONDS

Capita Gwent Consultancy Ltd.
TY Gwent, Lake View, Llantarnam Park, Cwmbran, South Wales. NP44 3HR
Tel: 01633 463333 Fax: 01633 463399

DRAWN	O.JONES	03/05	SCALE: 1:5000
CHECKED	O.J.B.SMITH	03/05	



DRG. No. Figure 2.2 REVISION REF.

- KEY:
- ATC LOCATIONS
 - MCC LOCATIONS

RECEIVED

22 APR 2003

ENR AND LOCAL RECEIVED

© Crown copyright. All rights reserved.
Licence No. 100020449

ISSUE	AMENDMENTS	DRAWN	CHK'D	DATE
-	-	-	-	-







Llywodraeth Cynulliad Cymru
Welsh Assembly Government

LAND NORTH OF THE RAILWAY LINE,
RHOOSE, VALE OF GLAMORGAN

TRAFFIC COUNTS LOCATION

CAPITA SYMONDS

Capita Gwent Consultancy Ltd.
Ty Gwent, Lake View, Llantarnam Park, Cwmbran, South Wales. NP44 3HR
Tel: 01633 463333 Fax: 01633 463399

DRAWN	G. B. WILLIAMS	03/05	SCALE:
CHECKED	O. J. B. SMITH	03/05	NOT TO SCALE

DRG. No. Figure 2.2 REVISION REF.

ISSUE	AMENDMENTS	DRAWN	CHECKED	DATE



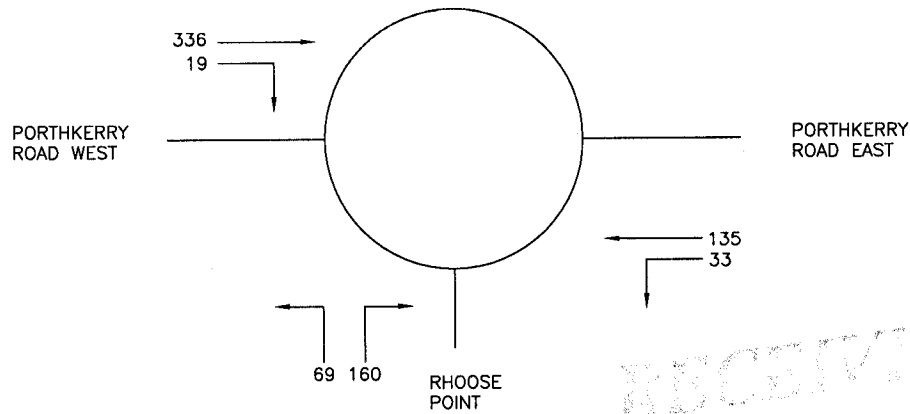

AM PEAK (08:00 - 09:00)

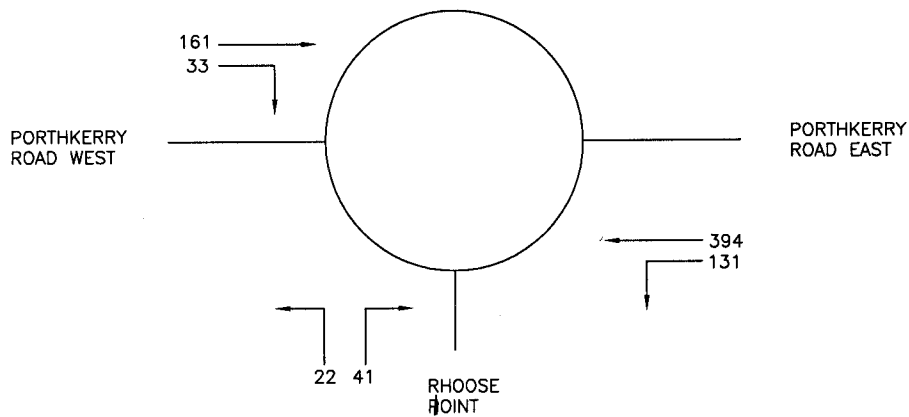

RECEIVED
22 APR 2008
ENVIRONMENTAL
APPROVALS
REGISTRATION

PM PEAK (17:00 - 18:00)

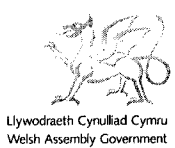

CLIENT   	PROJECT LAND TO THE NORTH OF RAILWAY LINE, RHOOSE. VALE OF GLAMORGAN	CAPITA SYMONDS <small>Capita Gwent Consultancy Limited Ty Cwent, Llantrann Park, Cwmbran, Torfaen, NP44 3HR Tel: 01633 463333 Fax: 01633 463399 www.capitasymonds.co.uk</small> 									
	TITLE TRAFFIC FLOWS 2004 PORTHKERRY ROAD / RHOOSE POINT ACCESS ROAD R/A	<table border="1"> <tr> <td>DRAWN O. JONES</td> <td>DATE MARCH 2005</td> <td>SCALE DIAGRAMMATIC</td> </tr> <tr> <td>CHECKED C. GOODALL</td> <td>DATE MARCH 2005</td> <td>PROJECT No. CG7550</td> </tr> </table>	DRAWN O. JONES	DATE MARCH 2005	SCALE DIAGRAMMATIC	CHECKED C. GOODALL	DATE MARCH 2005	PROJECT No. CG7550	<table border="1"> <tr> <td>DRG. No. FIGURE 2.3</td> <td>REVISION REF.</td> </tr> </table>		DRG. No. FIGURE 2.3
DRAWN O. JONES	DATE MARCH 2005	SCALE DIAGRAMMATIC									
CHECKED C. GOODALL	DATE MARCH 2005	PROJECT No. CG7550									
DRG. No. FIGURE 2.3	REVISION REF.										
PURPOSE											

ISSUE	AMENDMENTS	DRAWN	CHECKED	DATE



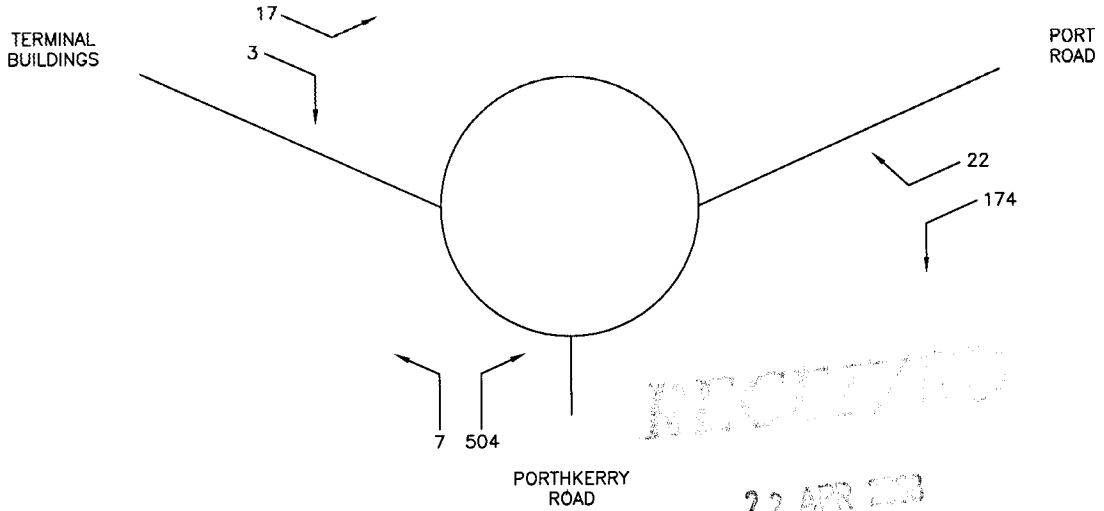

AM PEAK (08:00 - 09:00)

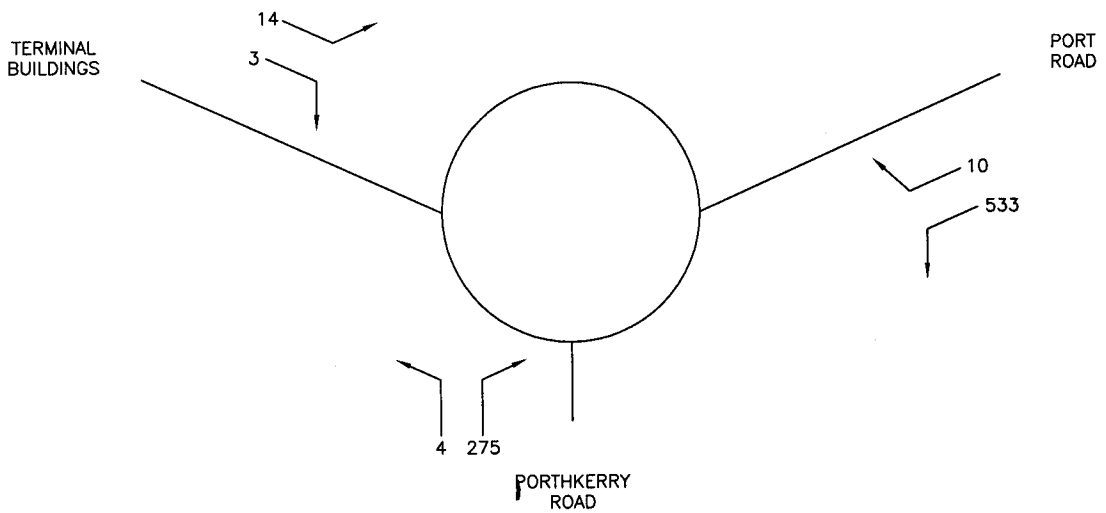

RECEIVED
22 APR 2005
ENVI...
AND...
RECOMMENDATION

PM PEAK (17:00 - 18:00)



CLIENT    Llywodraeth Cynulliad Cymru Welsh Assembly Government	PROJECT LAND TO THE NORTH OF RAILWAY LINE, RHOOSE. VALE OF GLAMORGAN	CAPITA SYMONDS <small>Capita Gwent Consultancy Limited Ty Gwent, Llantrann Park, Cwmbran, Torfaen, NP44 3HR Tel: 01633 463333 Fax: 01633 463399 www.capitasymonds.co.uk</small> 		
	TITLE TRAFFIC FLOWS 2004 PORT ROAD / PORKHERRY ROAD R/A	DRAWN O. JONES	DATE MARCH 2005	SCALE DIAGRAMMATIC
PURPOSE *	CHECKED C. GOODALL	DATE MARCH 2005	PROJECT No. CG7550	
	DRG. No. FIGURE 2.4	REVISION REF.		

ISSUE	AMENDMENTS	DRAWN	CHECKED	DATE

AM PEAK (08:00 - 09:00)

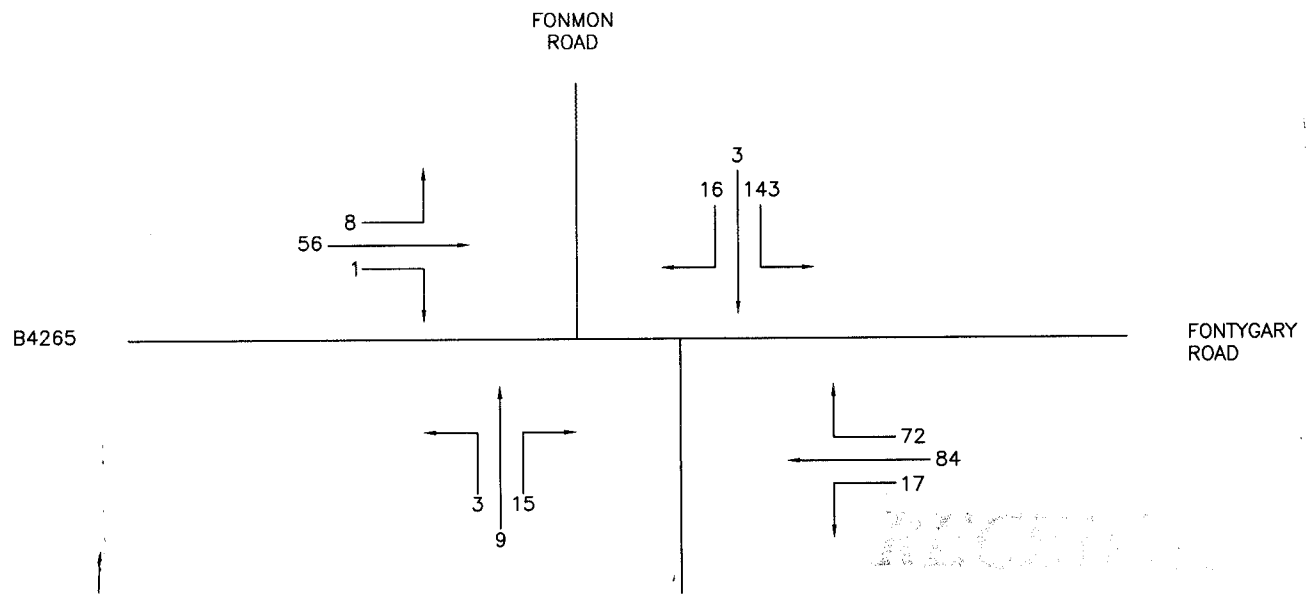



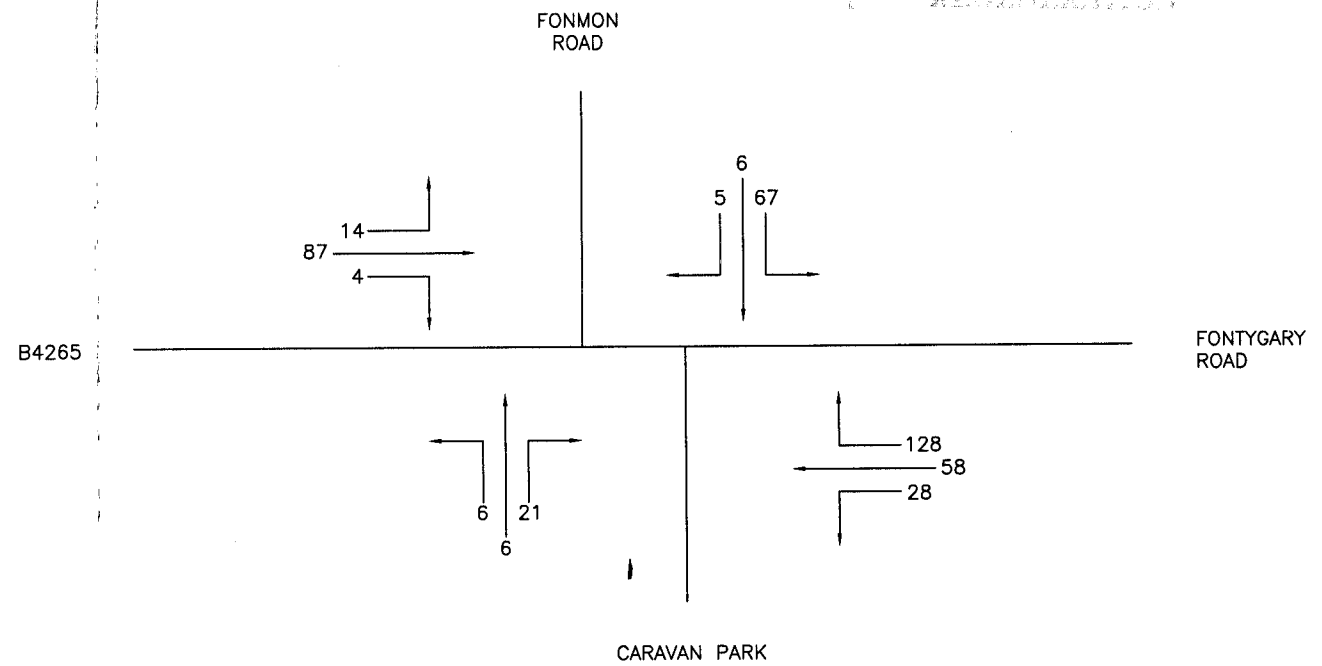

PM PEAK (17:00 - 18:00)



RECEIVED

22 APR 2005

ENVELOPE L
A4
RECEIVED

CLIENT   	PROJECT LAND TO THE NORTH OF RAILWAY LINE, RHOOSE. VALE OF GLAMORGAN	CAPITA SYMONDS <small>Capita Gwent Consultancy Limited Tŷ Cwent, Llantarnam Park, Cwmbran, Torfaen, NP44 3HR Tel: 01633 463333 Fax: 01633 463399 www.capitasymonds.co.uk</small> 	
	TITLE TRAFFIC FLOWS 2004 FONTYGARY SIGNALS	DRAWN O. JONES	DATE MARCH 2005
PURPOSE	CHECKED C. GOODALL	DATE MARCH 2005	PROJECT No. CG7550
	DRG. No. FIGURE 2.5	REVISION REF.	

ISSUE	AMENDMENTS	DRAWN	CHECKED	DATE



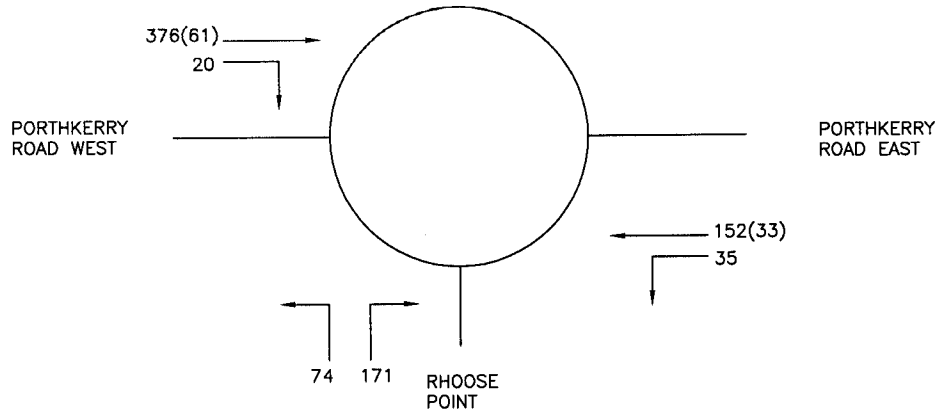

AM PEAK (08:00 - 09:00)

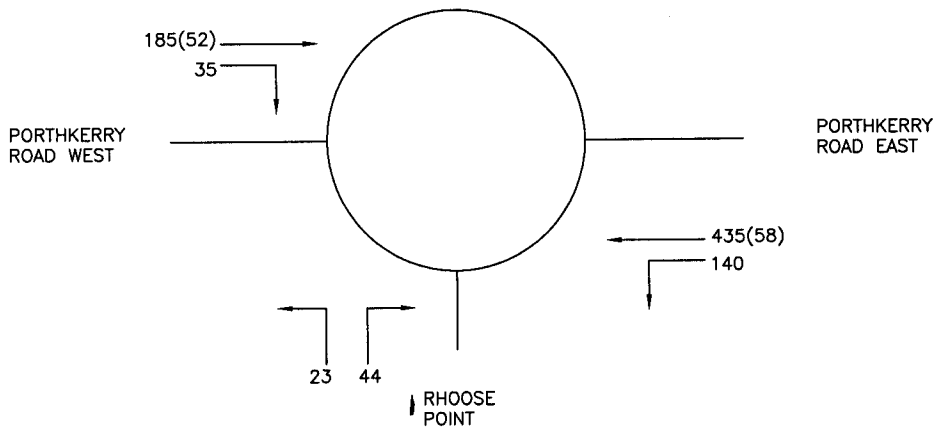

PM PEAK (17:00 - 18:00)



RECEIVED
22 APR 2005
CAPITA SYMONDS
TRAFFIC ENGINEERING
REGISTRATION

CLIENT   	PROJECT LAND TO THE NORTH OF RAILWAY LINE, RHOOSE. VAL E OF GLAMORGAN	CAPITA SYMONDS <small>Capita Gwent Consultancy Limited Ty Gwent, Llantarnam Park, Cwmbran, Torfaen, NP44 3HR Tel: 01633 463333 Fax: 01633 463399 www.capitasymonds.co.uk</small> 		
	TITLE TRAFFIC FLOWS 2008 PORTHKERRY ROAD/ RHOOSE POINT ACCESS ROAD R/A (NO DEVELOPMENT)	DRAWN O. JONES	DATE MARCH 2005	SCALE DIAGRAMMATIC
PURPOSE 	CHECKED C. GOODALL	DATE MARCH 2005	PROJECT No. CG7550	
	DRG. No. FIGURE 2.6	REVISION REF.		

ISSUE	AMENDMENTS	DRAWN	CHECKED	DATE

AM PEAK (08:00 - 09:00)

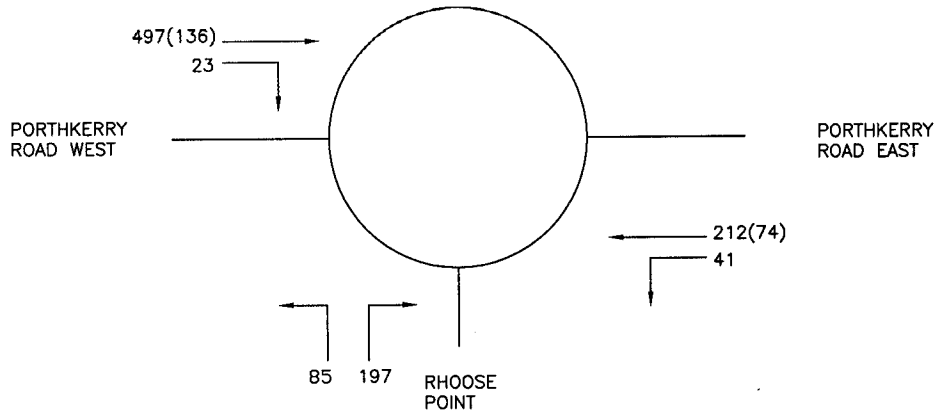

PM PEAK (17:00 - 18:00)

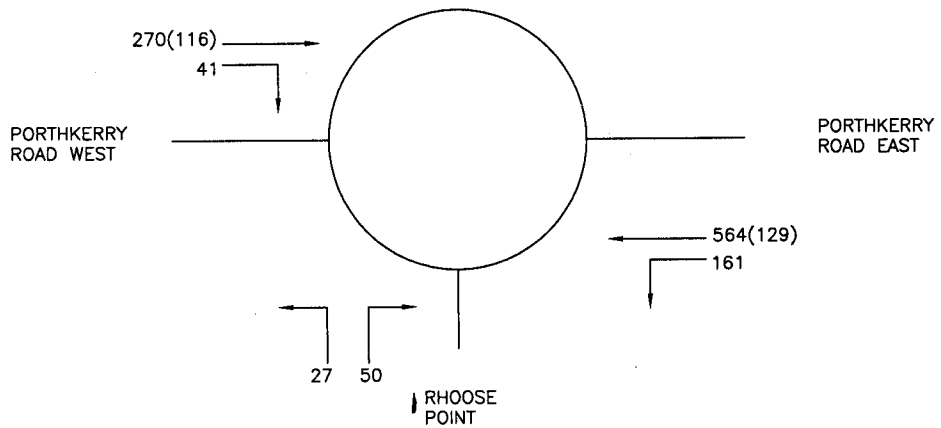

RECEIVED

22 APR 2008

ELITE CONSULTING
AVIATION
REGISTRATION

CLIENT



Llywodraeth Cynulliad Cymru
Welsh Assembly Government

PROJECT

LAND TO THE NORTH OF RAILWAY LINE,
RHOOSE. VAL E OF GLAMORGAN

TITLE

TRAFFIC FLOWS 2018
PORTHKERRY ROAD/
RHOOSE POINT ACCESS ROAD R/A
(NO DEVELOPMENT)

PURPOSE

CAPITA SYMONDS

Capita Gwent Consultancy Limited
Ty Cowent, Llantararn Park, Cwmbran, Torfaen, NP44 3HR
Tel: 01633 463333 Fax: 01633 463399
www.capitasymonds.co.uk



DRAWN O. JONES	DATE MARCH 2005	SCALE DIAGRAMMATIC
CHECKED C. GOODALL	DATE MARCH 2005	PROJECT No. CG7550
DRG. No. FIGURE 2.7	REVISION REF.	

ISSUE	AMENDMENTS	DRAWN	CHECKED	DATE



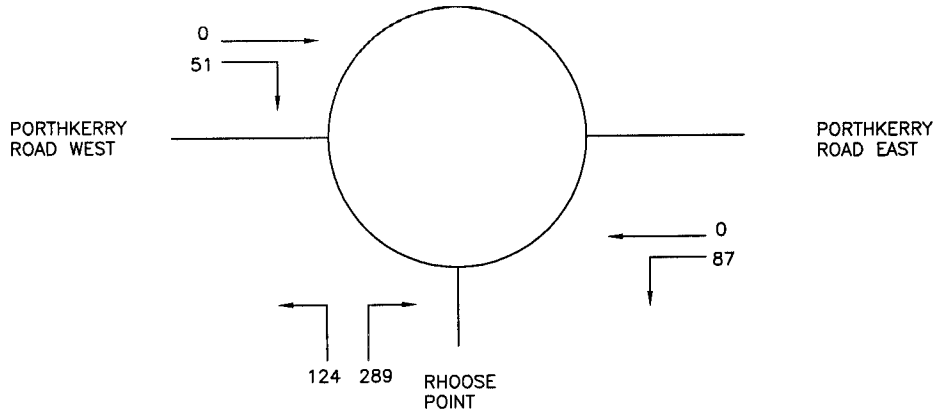

AM PEAK (08:00 - 09:00)

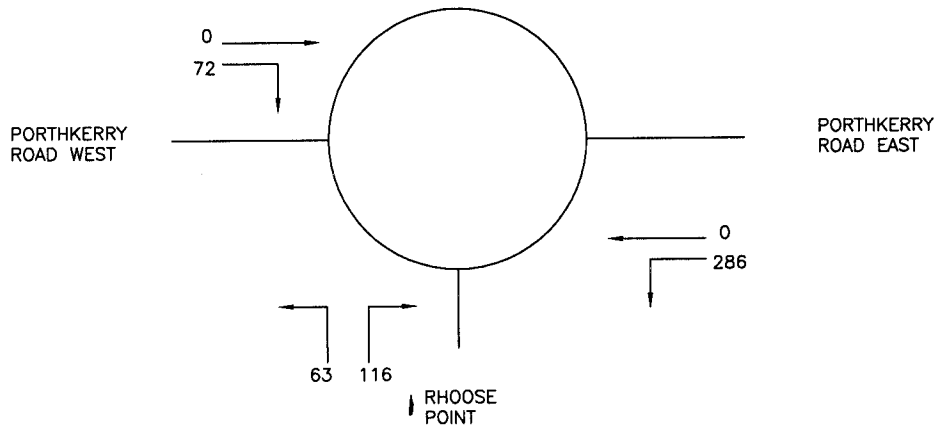

PM PEAK (17:00 - 18:00)



RECEIVED
22 APR 2005
DRG. 2.8
AMOUNT OF TRAFFIC
RECOMMENDED

CLIENT    Llywodraeth Cynulliad Cymru Welsh Assembly Government	PROJECT LAND TO THE NORTH OF RAILWAY LINE, RHOOSE. VAL E OF GLAMORGAN	CAPITA SYMONDS <small>Capita Gwent Consultancy Limited Tŷ Gwent, 11antarn Park, Cwmbran, Torfaen, NP44 3HR Tel: 01633 463333 Fax: 01633 463399 www.capitasymonds.co.uk</small> 		
	TITLE DEVELOPMENT FLOWS PORTHKERRY ROAD/ RHOOSE POINT ACCESS ROAD R/A	DRAWN O. JONES	DATE MARCH 2005	SCALE DIAGRAMMATIC
PURPOSE	CHECKED C. GOODALL	DATE MARCH 2005	PROJECT No. CG7550	
	DRG. No. FIGURE 2.8		REVISION REF.	

ISSUE	AMENDMENTS	DRAWN	CHECKED	DATE

AM PEAK (08:00 - 09:00)

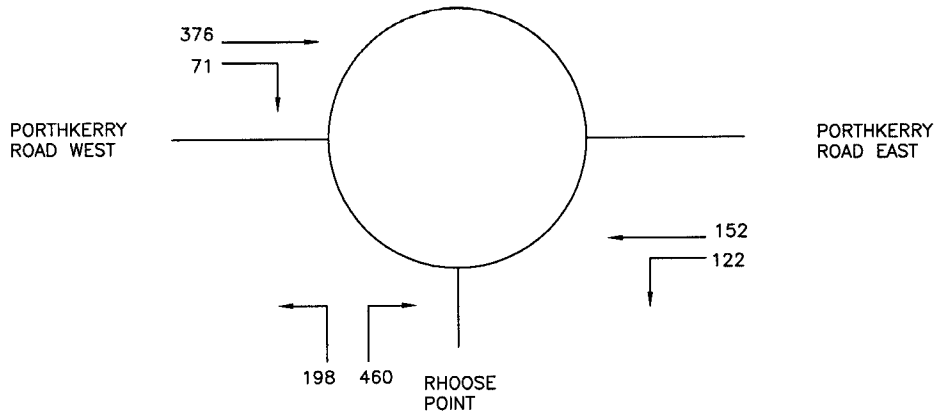

PM PEAK (17:00 - 18:00)

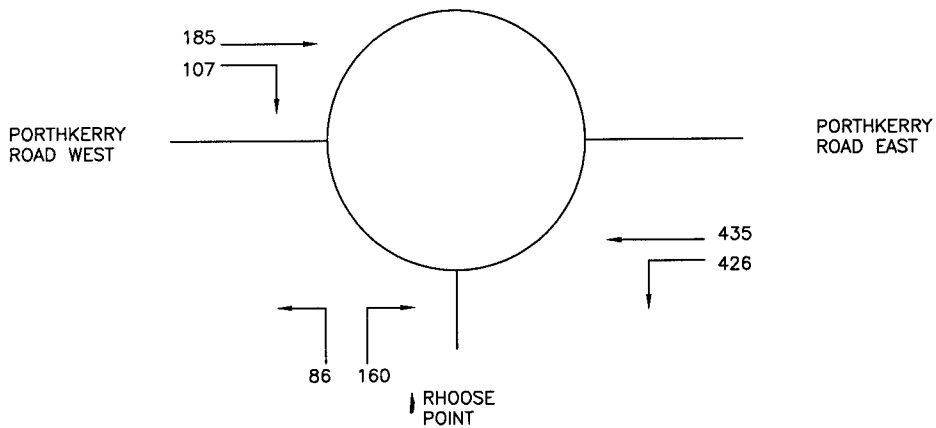

RECEIVED

22 APR 2008

ENVIRONMENTAL
AND
PLANNING
CONSULTANTS

CLIENT

Llywodraeth Cynulliad Cymru
Welsh Assembly Government

PROJECT
LAND TO THE NORTH OF RAILWAY LINE,
RHOOSE. VAL E OF GLAMORGAN

TITLE
TRAFFIC FLOWS 2008
PORTHKERRY ROAD/
RHOOSE POINT ACCESS ROAD R/A
(WITH DEVELOPMENT)

PURPOSE

CAPITA SYMONDS

Capita Gwent Consultancy Limited
Ty Cwent, Llanernam Park, Cwmbran, Torfaen, NP44 3HR
Tel: 01633 463333 Fax: 01633 463399
www.capitasymonds.co.uk

DRAWN O. JONES	DATE MARCH 2005	SCALE DIAGRAMMATIC
CHECKED C. GOODALL	DATE MARCH 2005	PROJECT No. CG7550
DRG. No. FIGURE 2.9	REVISION REF.	

ISSUE	AMENDMENTS	DRAWN	CHECKED	DATE

AM PEAK (08:00 - 09:00)

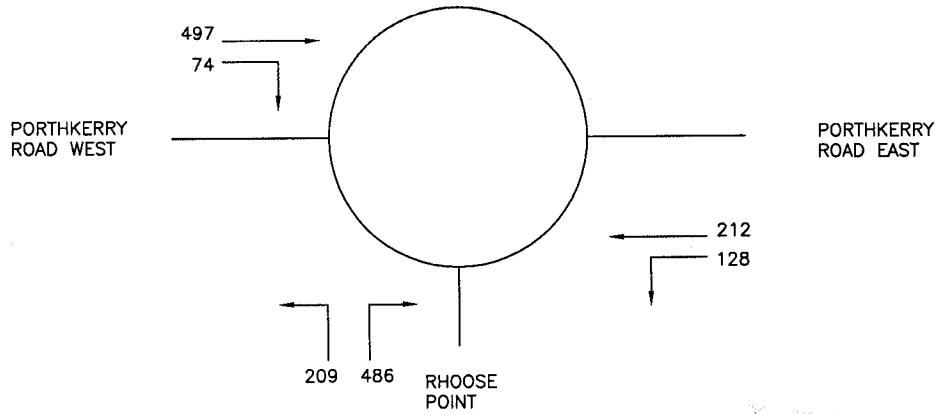

PM PEAK (17:00 - 18:00)

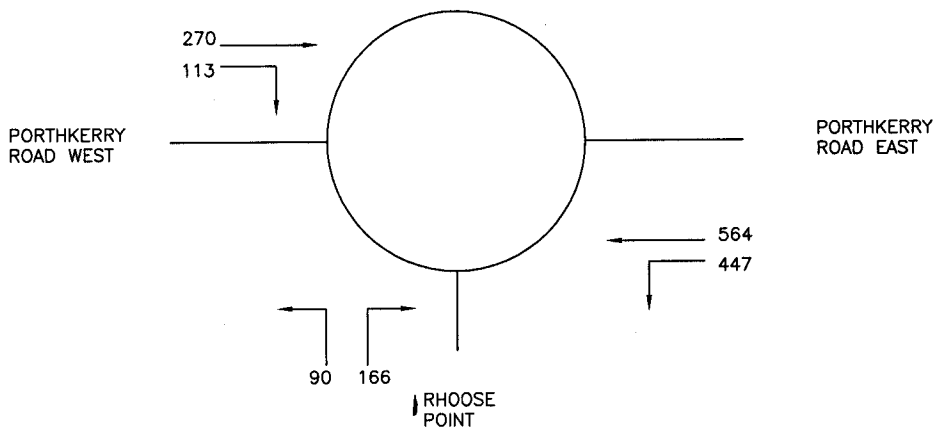

22 APR 2005

CLIENT



Llywodraeth Cynulliad Cymru
Welsh Assembly Government

PROJECT

LAND TO THE NORTH OF RAILWAY LINE,
RHOOSE. VAL E OF GLAMORGAN

TITLE

TRAFFIC FLOWS 2018
PORTHKERRY ROAD/
RHOOSE POINT ACCESS ROAD R/A
(WITH DEVELOPMENT)

PURPOSE

CAPITA SYMONDS

Capita Gwent Consultancy Limited
Ty Gwent, Llantarnam Park, Cwmbran, Torfaen, NP44 3HR
Tel: 01633 463333 Fax: 01633 463399
www.capitasymonds.co.uk



DRAWN O. JONES	DATE MARCH 2005	SCALE DIAGRAMMATIC
CHECKED C. GOODALL	DATE MARCH 2005	PROJECT No. CG7550
DRG. No. FIGURE 2.10	REVISION REF.	



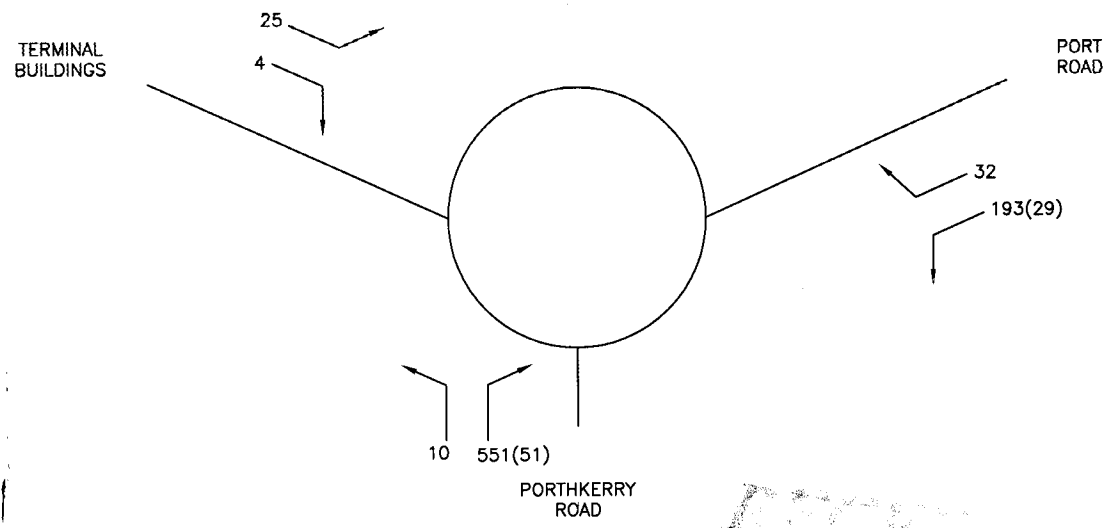

ISSUE	AMENDMENTS	DRAWN	CHECKED	DATE

AM PEAK (08:00 - 09:00)

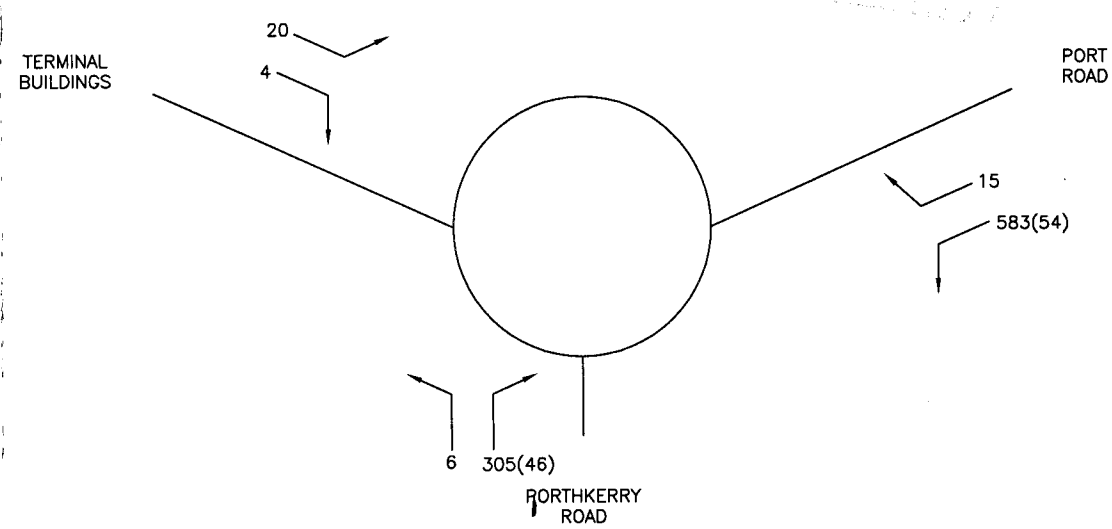

PM PEAK (17:00 - 18:00)



CLIENT    Llywodraeth Cynulliad Cymru Welsh Assembly Government	PROJECT LAND TO THE NORTH OF RAILWAY LINE, RHOOSE. VALE OF GLAMORGAN	CAPITA SYMONDS <small>Capita Gwent Consultancy Limited Ty Gwent, Llantarnam Park, Cwmbran, Torfaen, NP44 3HR Tel: 01633 463333 Fax: 01633 463999 www.capitasymonds.co.uk</small> 		
	TITLE TRAFFIC FLOWS 2008 PORT ROAD / PORTHERRY ROAD R/A (NO DEVELOPMENT)	DRAWN O. JONES	DATE MARCH 2005	SCALE DIAGRAMMATIC
PURPOSE	CHECKED C. GOODALL	DATE MARCH 2005	PROJECT No. CG7550	
	DRG. No. FIGURE 2.11	REVISION REF.		

ISSUE	AMENDMENTS	DRAWN	CHECKED	DATE

AM PEAK (08:00 - 09:00)

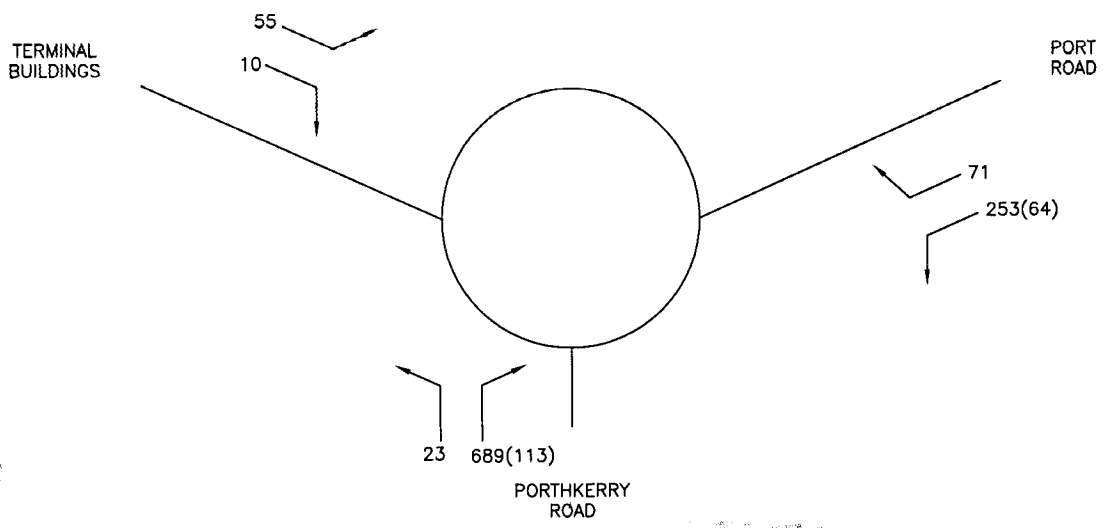

RECEIVED

22 APR 2008

Engineering Department
 100 BUCKINGHAM
 100 BUCKINGHAM

PM PEAK (17:00 - 18:00)

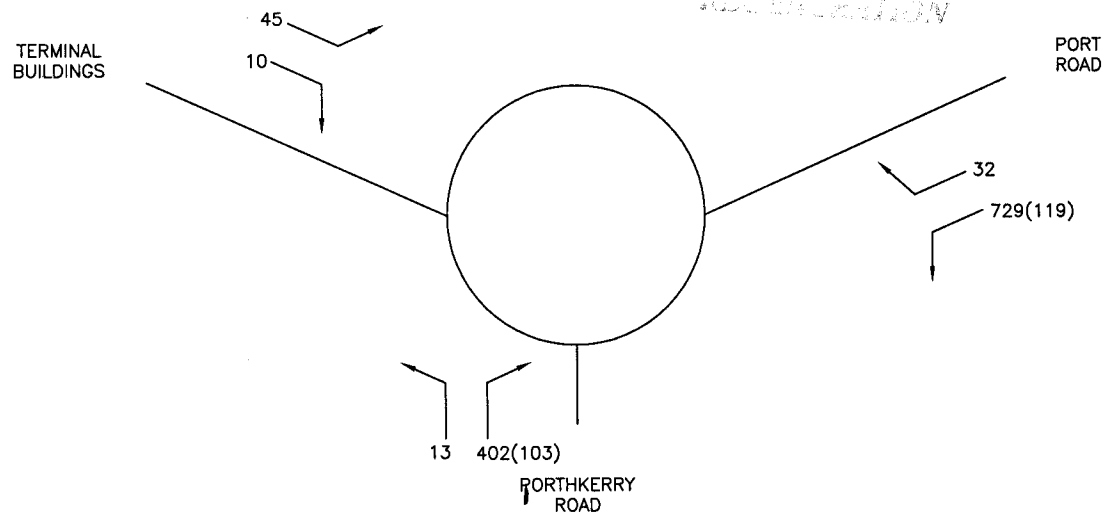

CLIENT Llywodraeth Cynulliad Cymru Welsh Assembly Government	PROJECT LAND TO THE NORTH OF RAILWAY LINE, RHOOSE. VALE OF GLAMORGAN	CAPITA SYMONDS <small>Capita Cwent Consultancy Limited Tŷ Cwent, Llantarnam Park, Cwmbran, Torfaen, NP44 3HR Tel: 01633 463333 Fax: 01633 463399 www.capitasymonds.co.uk</small>		
	TITLE TRAFFIC FLOWS 2018 PORT ROAD / PORKHERRY ROAD R/A (NO DEVELOPMENT)	DRAWN O. JONES	DATE MARCH 2005	SCALE DIAGRAMMATIC
PURPOSE (blank)	CHECKED C. GOODALL	DATE MARCH 2005	PROJECT No. CG7550	
	DRG. No. FIGURE 2.12	REVISION REF.		

ISSUE	AMENDMENTS	DRAWN	CHECKED	DATE

AM PEAK (08:00 - 09:00)

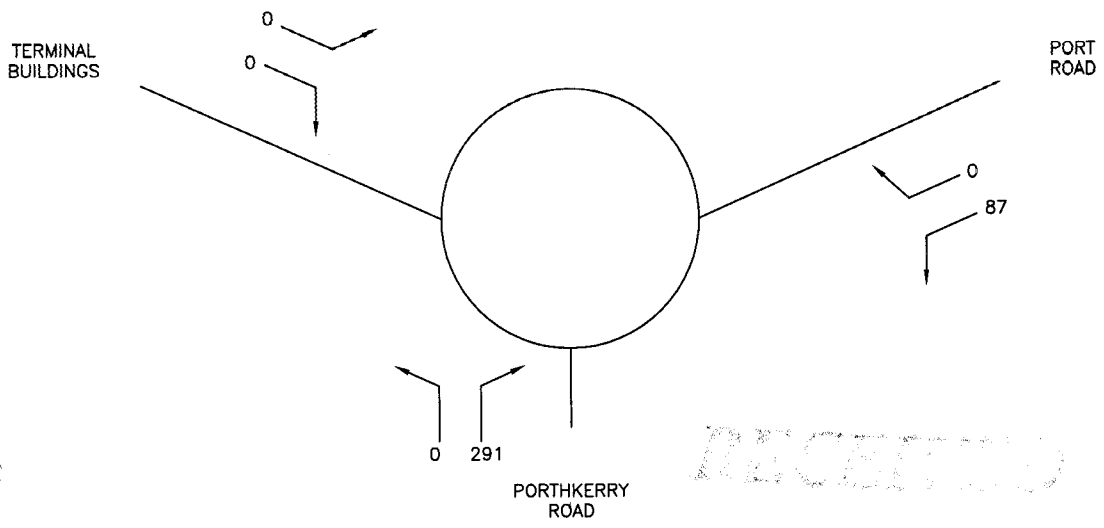





RECEIVED

22 APR 2005

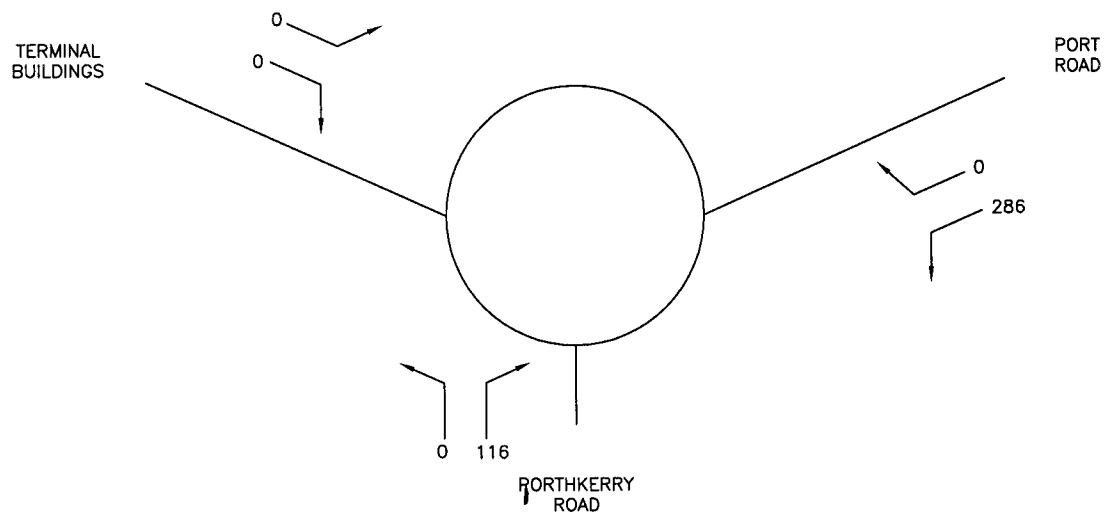
FOR THE DEVELOPMENT OF
LAND TO THE NORTH OF RAILWAY LINE,
RHOOSE, VALE OF GLAMORGAN

PM PEAK (17:00 - 18:00)



CLIENT    Llywodraeth Cynulliad Cymru Welsh Assembly Government	PROJECT LAND TO THE NORTH OF RAILWAY LINE, RHOOSE, VALE OF GLAMORGAN	CAPITA SYMONDS <small>Capita Gwent Consultancy Limited Tŷ Gwent, Llantarnam Park, Cwmbran, Torfaen, NP44 3HR Tel: 01633 463333 Fax: 01633 463399 www.capitasymonds.co.uk</small> 		
	TITLE DEVELOPMENT FLOWS PORT ROAD / PORTHERRY ROAD R/A	DRAWN O. JONES	DATE MARCH 2005	SCALE DIAGRAMMATIC
PURPOSE	CHECKED C. GOODALL	DATE MARCH 2005	PROJECT No. CG7550	
	DRG. No. FIGURE 2.13	REVISION REF.		



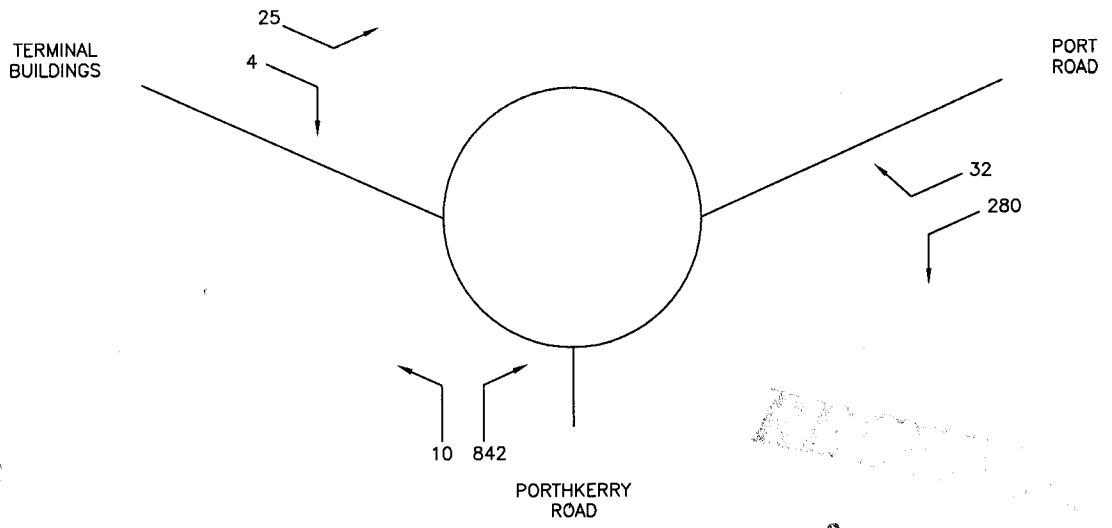

ISSUE	AMENDMENTS	DRAWN	CHECKED	DATE

AM PEAK (08:00 - 09:00)

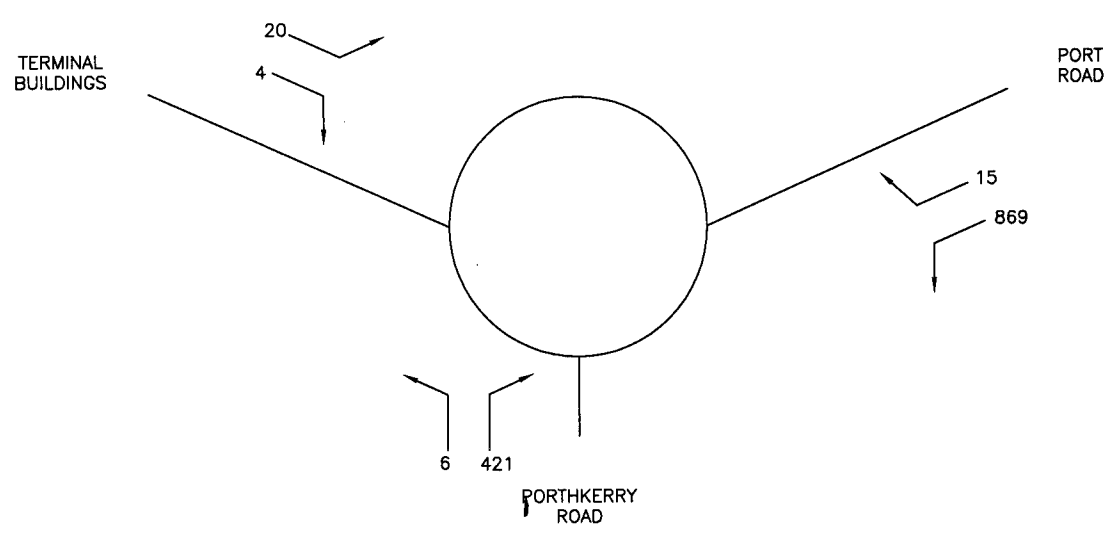

PM PEAK (17:00 - 18:00)



CLIENT    Llywodraeth Cynulliad Cymru Welsh Assembly Government	PROJECT LAND TO THE NORTH OF RAILWAY LINE, RHOOSE. VALE OF GLAMORGAN	CAPITA SYMONDS <small>Capita Cwent Consultancy Limited Ty Gwent, Llanernam Park, Cwmbran, Torfaen, NP44 3HR Tel: 01633 463333 Fax: 01633 463399 www.capitasymonds.co.uk</small> 			
	TITLE TRAFFIC FLOWS 2008 PORT ROAD / PORTHERRY ROAD R/A (WITH DEVELOPMENT)	DRAWN O. JONES	DATE MARCH 2005	SCALE DIAGRAMMATIC	
	PURPOSE	CHECKED C. GOODALL	DATE MARCH 2005	PROJECT No. CG7550	
		DRG. No. FIGURE 2.14	REVISION REF.		

ISSUE	AMENDMENTS	DRAWN	CHECKED	DATE

AM PEAK (08:00 - 09:00)

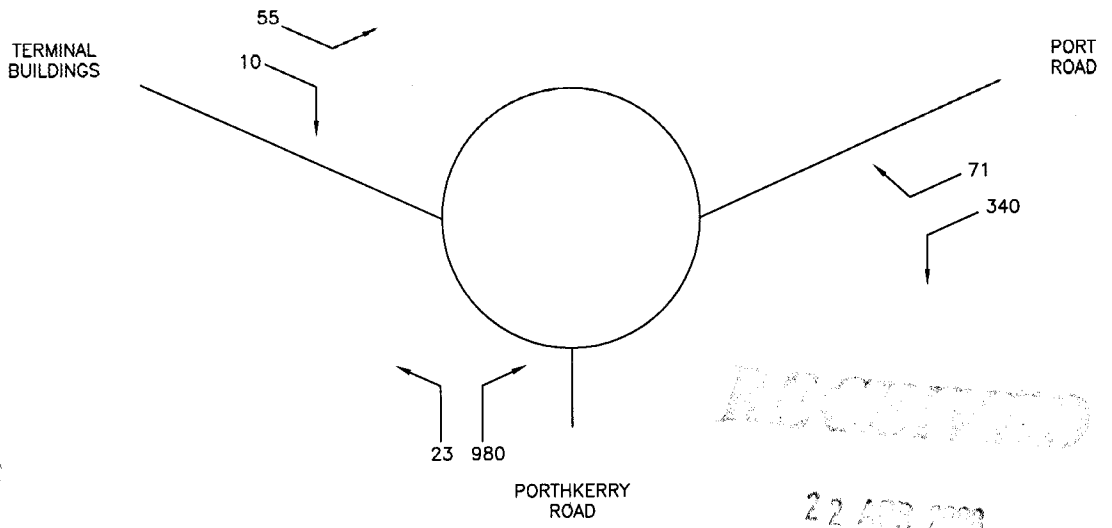

PM PEAK (17:00 - 18:00)

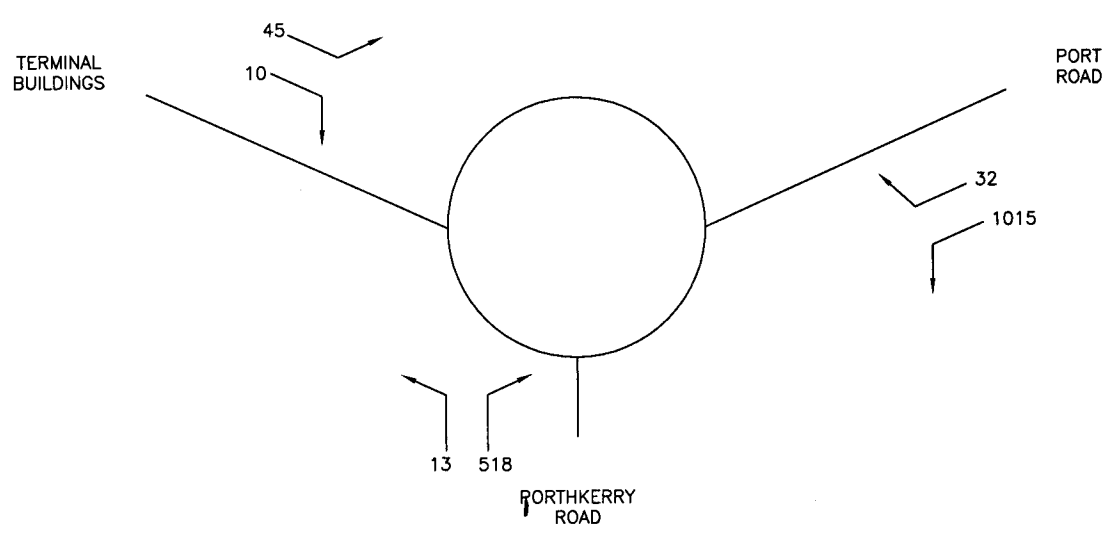

CLIENT Llywodraeth Cynulliad Cymru Welsh Assembly Government	PROJECT LAND TO THE NORTH OF RAILWAY LINE, RHOOSE. VALE OF GLAMORGAN	CAPITA SYMONDS <small>Capita Cwent Consultancy Limited Tŷ Cwent, Llantarnam Park, Cwmbran, Torfaen, NP44 3HR Tel: 01633 463333 Fax: 01633 463399 www.capitasymonds.co.uk</small>		
	TITLE TRAFFIC FLOWS 2018 PORT ROAD / PORTKERRY ROAD R/A (WITH DEVELOPMENT)	DRAWN O. JONES	DATE MARCH 2005	SCALE DIAGRAMMATIC
PURPOSE	CHECKED C. GOODALL	DATE MARCH 2005	PROJECT No. CG7550	
	DRG. No. FIGURE 2.15	REVISION REF.		

ISSUE	AMENDMENTS	DRAWN	CHECKED	DATE

AM PEAK (08:00 - 09:00)

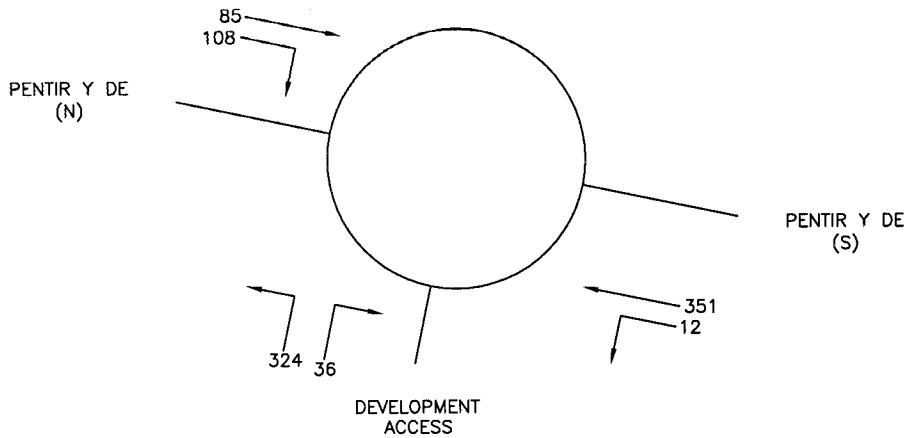

RECEIVED

22 APR 2005

DR. C. GOODALL
 ALLEGEDLY

PM PEAK (17:00 - 18:00)

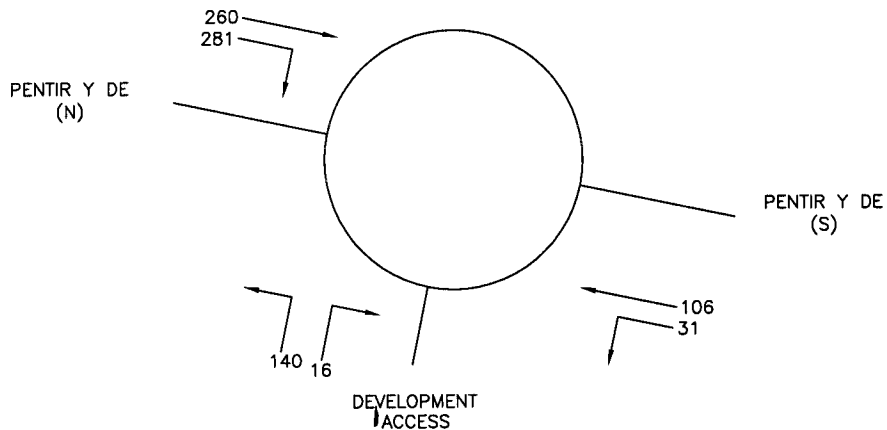

CLIENT Llywodraeth Cynulliad Cymru Welsh Assembly Government	PROJECT LAND TO THE NORTH OF RAILWAY LINE, RHOOSE. VALE OF GLAMORGAN	CAPITA SYMONDS <small>Capita Cwent Consultancy Limited Ty Cwent, Llantarnam Park, Cwmbran, Torfaen, NP44 3HR Tel: 01633 463333 Fax: 01633 463399 www.capitasymonds.co.uk</small>		
	TITLE TRAFFIC FLOWS 2023 DEVELOPMENT ACCESS ROUNDABOUT (WITH DEVELOPMENT)	DRAWN O. JONES	DATE MARCH 2005	SCALE DIAGRAMMATIC
PURPOSE #	DRG. No. FIGURE 2.16	CHECKED C. GOODALL	DATE MARCH 2005	PROJECT No. CG7550
			REVISION REF.	

ISSUE	AMENDMENTS	DRAWN	CHECKED	DATE

AM PEAK (08:00 - 09:00)

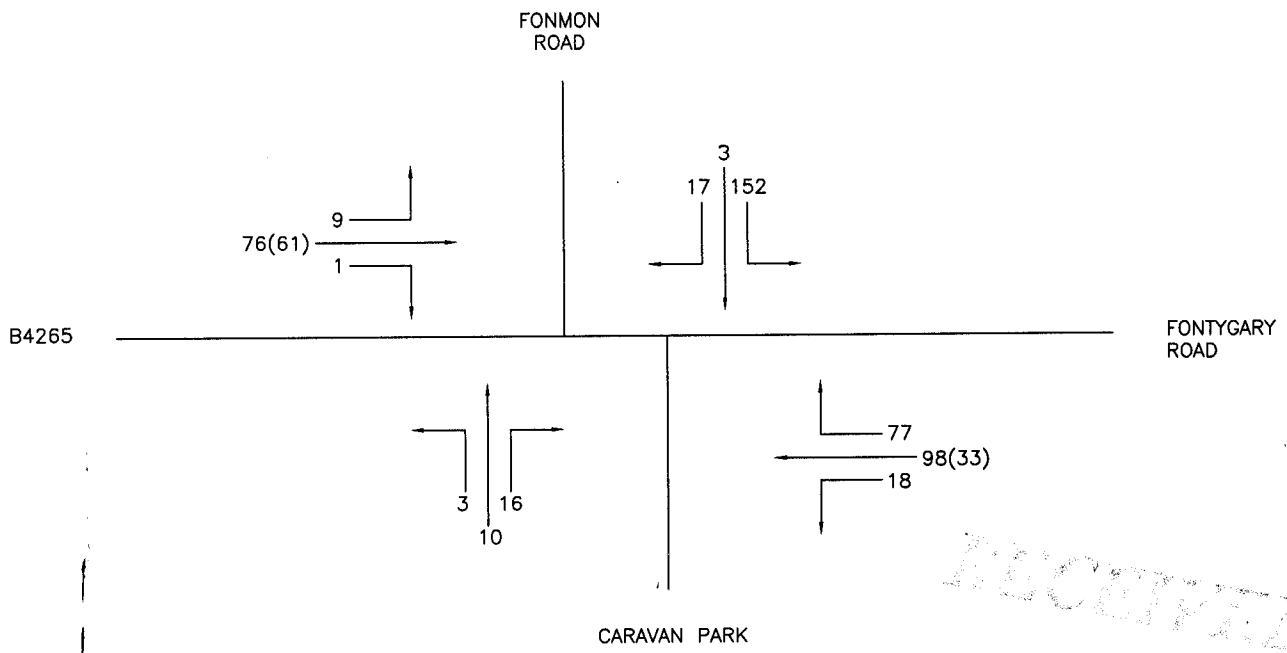

PM PEAK (17:00 - 18:00)

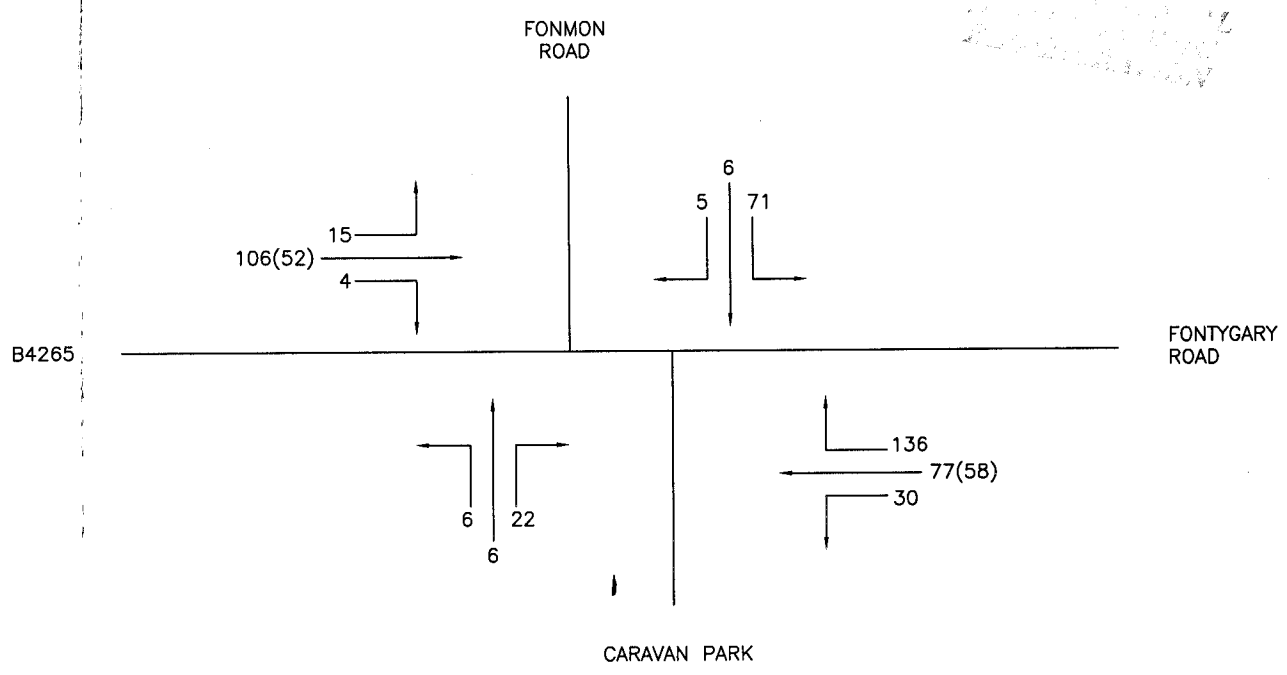

RECEIVED
22 APR 2008
CAPITA SYMONDS
22 APR 2008

CLIENT Llywodraeth Cynulliad Cymru Welsh Assembly Government	PROJECT LAND TO THE NORTH OF RAILWAY LINE, RHOOSE. VALE OF GLAMORGAN	CAPITA SYMONDS <small>Capita Gwent Consultancy Limited Ty Gwent, Llantarnam Park, Cwmbran, Torfaen, NP44 3HR Tel: 01633 463333 Fax: 01633 463399 www.capitasymonds.co.uk</small>								
	TITLE TRAFFIC FLOWS 2008 FONTYGARY SIGNALS (NO DEVELOPMENT)	<table border="1"> <tr> <td>DRAWN O. JONES</td> <td>DATE MARCH 2005</td> <td>SCALE DIAGRAMMATIC</td> </tr> <tr> <td>CHECKED C. GOODALL</td> <td>DATE MARCH 2005</td> <td>PROJECT No. CG7550</td> </tr> <tr> <td colspan="2">DRG. No. FIGURE 2.17</td> <td>REVISION REF.</td> </tr> </table>	DRAWN O. JONES	DATE MARCH 2005	SCALE DIAGRAMMATIC	CHECKED C. GOODALL	DATE MARCH 2005	PROJECT No. CG7550	DRG. No. FIGURE 2.17	
DRAWN O. JONES	DATE MARCH 2005	SCALE DIAGRAMMATIC								
CHECKED C. GOODALL	DATE MARCH 2005	PROJECT No. CG7550								
DRG. No. FIGURE 2.17		REVISION REF.								
PURPOSE										

ISSUE	AMENDMENTS	DRAWN	CHECKED	DATE

AM PEAK (08:00 - 09:00)

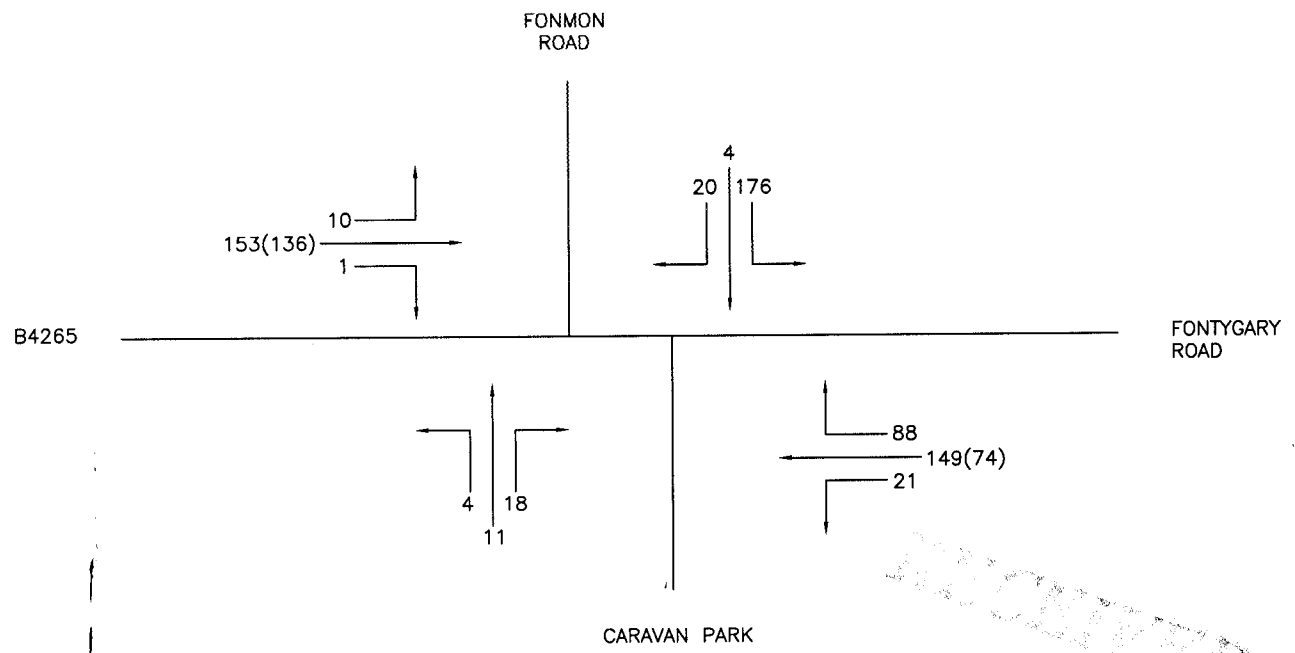

PM PEAK (17:00 - 18:00)

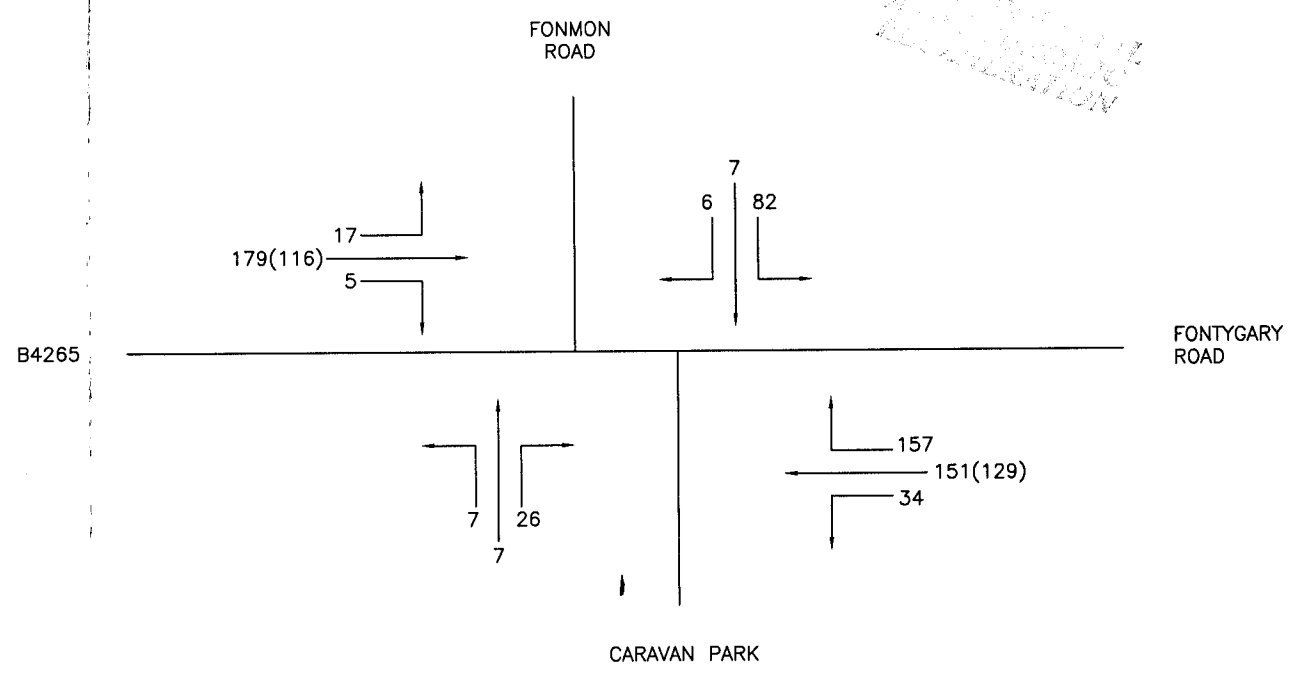

RECEIVED
 22 APR 2005
 CIVIL ENGINEERING
 PLANNING
 REGISTRATION

CLIENT Llywodraeth Cynulliad Cymru Welsh Assembly Government	PROJECT LAND TO THE NORTH OF RAILWAY LINE, RHOOSE. VALE OF GLAMORGAN	CAPITA SYMONDS <small>Capita Cwent Consultancy Limited Ty Cwent, Llantarnam Park, Cwmbran, Torfaen, NP44 3HR Tel: 01633 463333 Fax: 01633 463399 www.capitasymonds.co.uk</small>					
	TITLE TRAFFIC FLOWS 2018 FONTYGARY SIGNALS (NO DEVELOPMENT)				<table border="1"> <tr> <td>DRAWN O. JONES</td> <td>DATE MARCH 2005</td> <td>SCALE DIAGRAMMATIC</td> </tr> <tr> <td>CHECKED C. GOODALL</td> <td>DATE MARCH 2005</td> <td>PROJECT No. CG7550</td> </tr> </table>	DRAWN O. JONES	DATE MARCH 2005
DRAWN O. JONES	DATE MARCH 2005	SCALE DIAGRAMMATIC					
CHECKED C. GOODALL	DATE MARCH 2005	PROJECT No. CG7550					
PURPOSE	DRG. No. FIGURE 2.18	REVISION REF.					

ISSUE	AMENDMENTS	DRAWN	CHECKED	DATE



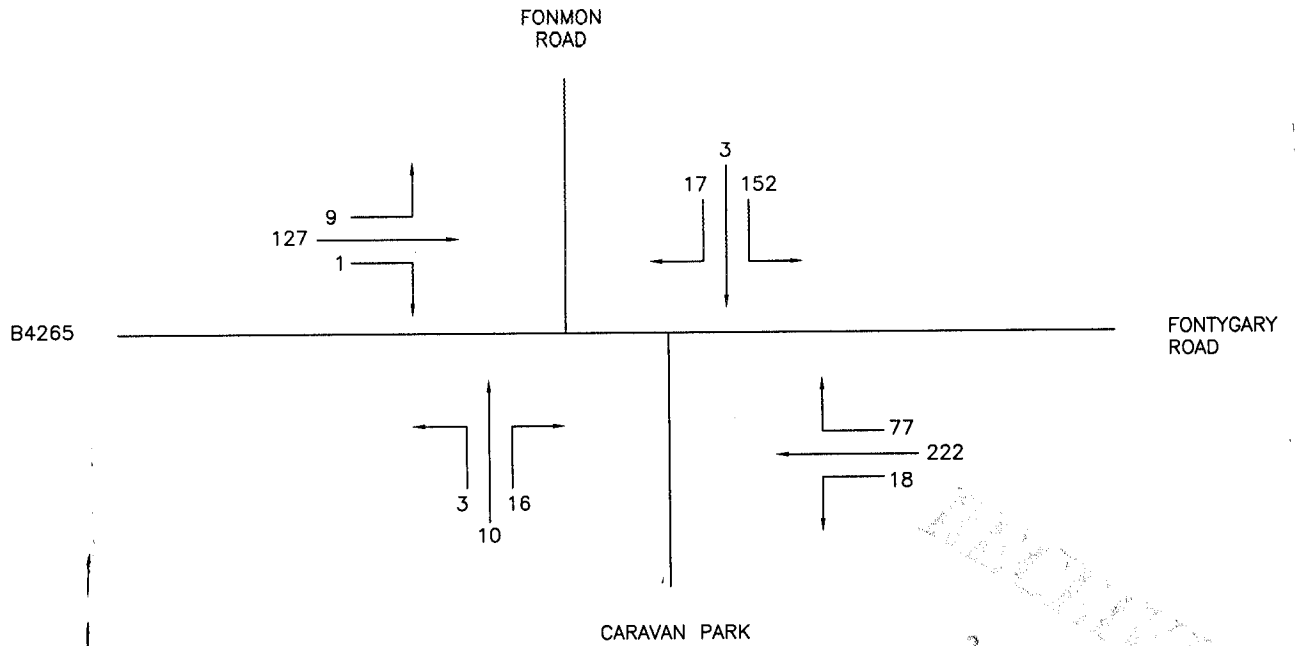

AM PEAK (08:00 - 09:00)

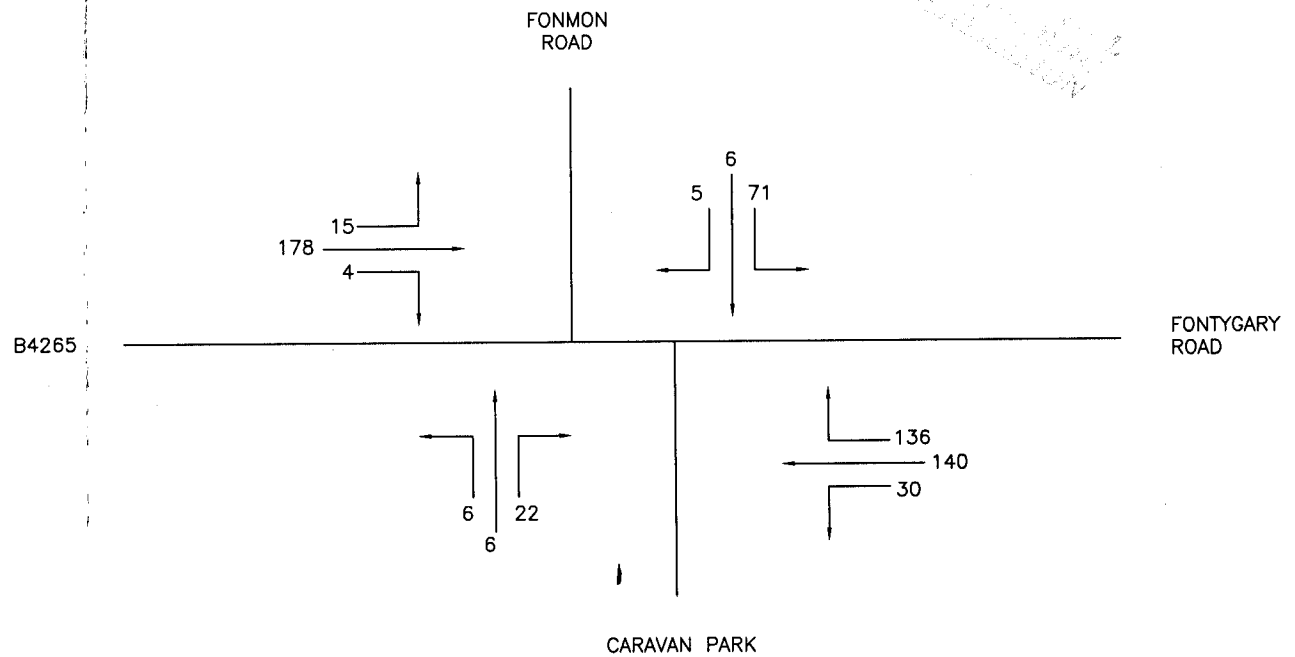

PM PEAK (17:00 - 18:00)



22 APR 2005
 ENIT...
 ...
 ...

<p>CLIENT</p>    <p>Llywodraeth Cynulliad Cymru Welsh Assembly Government</p>	<p>PROJECT</p> <p>LAND TO THE NORTH OF RAILWAY LINE, RHOOSE. VALE OF GLAMORGAN</p>	<p>CAPITA SYMONDS</p> <p><small>Capita Gwent Consultancy Limited Ty Cwent, Llantarnam Park, Cwmbran, Torfaen, NP44 3HR</small></p> <p><small>Tel: 01633 463333 Fax: 01633 463399 www.capitasymonds.co.uk</small></p> 												
	<p>TITLE</p> <p>TRAFFIC FLOWS 2008 FONTYGARY SIGNALS (WITH DEVELOPMENT)</p>	<table border="1"> <tr> <td style="font-size: small;">DRAWN</td> <td>O. JONES</td> <td style="font-size: small;">DATE</td> <td>MARCH 2005</td> <td style="font-size: small;">SCALE</td> <td>DIAGRAMMATIC</td> </tr> <tr> <td style="font-size: small;">CHECKED</td> <td>C. GOODALL</td> <td style="font-size: small;">DATE</td> <td>MARCH 2005</td> <td style="font-size: small;">PROJECT No.</td> <td>CG7550</td> </tr> </table>	DRAWN	O. JONES	DATE	MARCH 2005	SCALE	DIAGRAMMATIC	CHECKED	C. GOODALL	DATE	MARCH 2005	PROJECT No.	CG7550
	DRAWN	O. JONES	DATE	MARCH 2005	SCALE	DIAGRAMMATIC								
	CHECKED	C. GOODALL	DATE	MARCH 2005	PROJECT No.	CG7550								
<p>PURPOSE</p>	<p>DRG. No.</p> <p>FIGURE 2.20</p>	<p style="font-size: small;">REVISION REF.</p>												

ISSUE	AMENDMENTS	DRAWN	CHECKED	DATE

AM PEAK (08:00 - 09:00)

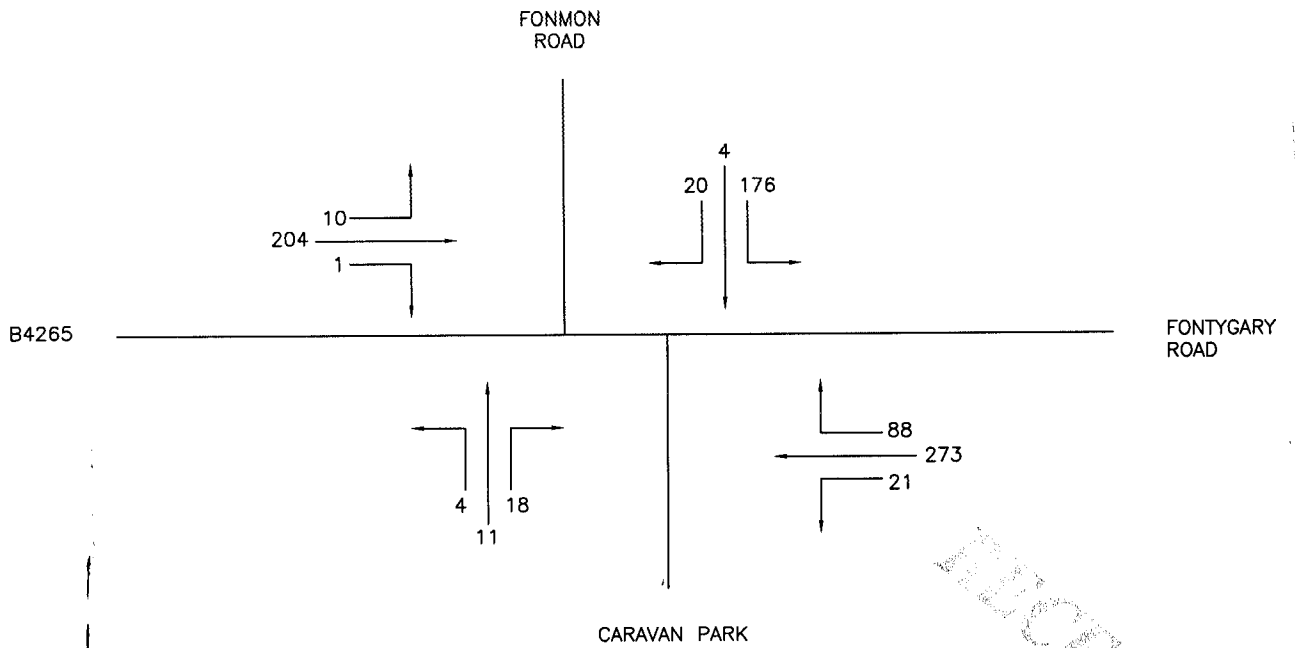

PM PEAK (17:00 - 18:00)

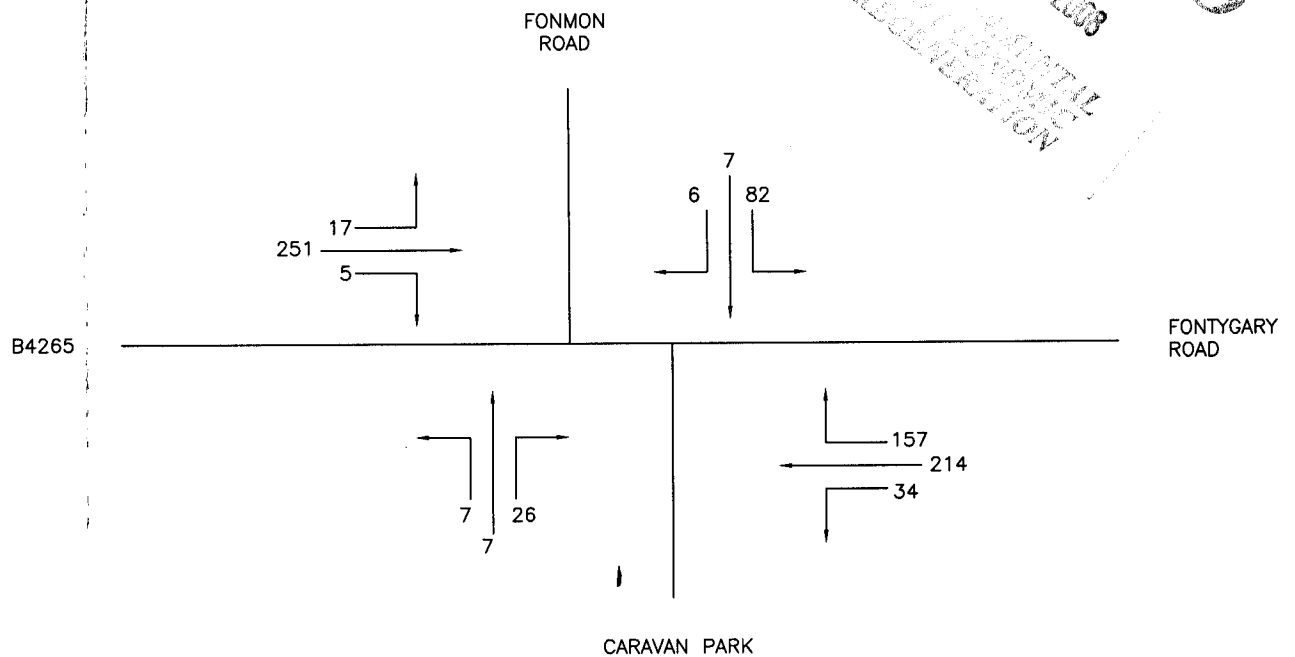

REVISIONS
 22 APR 2005
 ENRICHED
 4000 LANTARNAM PARK
 CWMBRAN, TORFAEN

CLIENT



Llywodraeth Cynulliad Cymru
Welsh Assembly Government

PROJECT

LAND TO THE NORTH OF RAILWAY LINE,
RHOOSE, VALE OF GLAMORGAN

TITLE

TRAFFIC FLOWS 2018
FONTYGARY SIGNALS
(WITH DEVELOPMENT)

PURPOSE

CAPITA SYMONDS

Capita Gwent Consultancy Limited
Tŷ Gwent, Llantarnam Park, Cwmbran, Torfaen, NP44 3HR

Tel: 01633 463333 Fax: 01633 463399
www.capitasymonds.co.uk



DRAWN O. JONES	DATE MARCH 2005	SCALE DIAGRAMMATIC
CHECKED C. GOODALL	DATE MARCH 2005	PROJECT No. CG7550
DRG. No. FIGURE 2.21	REVISION REF.	